



**Texto para Discussão 033 | 2020**

***Discussion Paper 033 | 2020***

## **The metamorphosis of external vulnerability from ‘original sin’ to ‘original sin redux’: Currency hierarchy and financial globalisation in emerging economies**

**Luiz Fernando de Paula**

*Professor of Economics at Federal University of Rio de Janeiro (IE/UFRJ), Coordinator of the Economics and Politics Studies Group at IESP/UERJ, and CNPq and FAPERJ Researcher*

**Barbara Fritz**

*Professor of Economics at Freie Universität Berlin*

**Daniela Prates**

*Senior Economic Affairs Officer at UNCTAD and Associate Professor (on leave) at IE-UNICAMP*

This paper can be downloaded without charge from

<http://www.ie.ufrj.br/index.php/index-publicacoes/textos-para-discussao>

# The metamorphosis of external vulnerability from ‘original sin’ to ‘original sin redux’: Currency hierarchy and financial globalisation in emerging economies<sup>1</sup>

November, 2020

## **Luiz Fernando de Paula**

*Professor of Economics at Federal University of Rio de Janeiro (IE/UFRJ), Coordinator of the Economics and Politics Studies Group at IESP/UERJ, and CNPq and FAPERJ Researcher*

## **Barbara Fritz**

*Professor of Economics at Freie Universität Berlin*

## **Daniela Prates**

*Senior Economic Affairs Officer at UNCTAD and Associate Professor (on leave) at IE-UNICAMP*

---

<sup>1</sup> Version: 17/09/2020

## **Abstract**

How has financial globalisation changed the nature of external vulnerability of emerging economies? To answer this question, we first present an overview of the changes in international capital flows and cross-border stocks involving emerging economies from the 1970s to the COVID-19 crisis, and then identify relevant recent shifts in financial globalisation. We link the concepts of financialisation, subordinated financial integration and currency hierarchy, extending the latter to consider the most recent features of financial globalisation. To better understand the metamorphosis of these economies' vulnerabilities, we deploy a stylised balance sheet analysis. We find the occurrence of the phenomenon of 'original sin' during financial internationalisation, while in more recent times of financial globalisation the diversification of financial flows and investors, and the increase of securities denominated in domestic currency have created additional channels of vulnerability, labelled as 'original sin redux'. We call for capital account regulation targeting these new complex vulnerabilities.

**Keywords:** external vulnerability; currency hierarchy; subordinated financial integration; financial globalisation; emerging markets economies

**JEL Classification:** F32; F34; F62

# 1 Introduction

The current economic and financial COVID-19 crisis has brought special hardship to most emerging market economies (EMEs)<sup>2</sup>. They have been suffering – as it happened at the global level – from local lockdown measures and the interruption of global value chains, while they were especially hit by capital outflows never seen before.

This unprecedented pro-cyclical response of global financial investors certainly relates to the new level and form of integration into financial globalisation. Here, we are confronted with a complex picture: on the one hand, we observe a wave of external debt accumulation during the 2010s (World Bank, 2020), while at the same time most EMEs have accumulated high levels of foreign exchange reserves, and – to different degrees – the share of those investors' assets denominated in EMEs domestic currency has increased. This new wave of instability places the new configurations of external vulnerability under the spotlight.

Financial globalisation is subject to fierce debate. Here, we draw on strands of critical discussion that emphasise the inherent instability of capital flows (i.e. Stiglitz and Ocampo, 2008). Especially relevant for the case of EMEs are concepts that consider the asymmetric nature of financialisation and financial globalisation, such as subordinated financial integration (Kaltenbrunner and Paincera, 2017; Bonizzi *et al.*, 2019), and the centre-periphery configuration of the international monetary system, such as the concept of currency hierarchy (Paula *et al.* 2017; Fritz *et al.* 2018; see also Andrade and Prates, 2014).

Departing from the perspective of an asymmetric and subordinated integration of EMEs into financial globalisation, we ask how we can understand and systematically depict the *new patterns of external vulnerability of EMEs and its implications in terms of risks?* What is the metamorphosis of this vulnerability along the different phases of financial

---

<sup>2</sup> Here we define EMEs as peripheral countries that have engaged in financial globalisation. We will use EMEs and emerging economies as synonyms.

globalisation? Our main hypothesis is that vulnerability overall has not decreased, but rather it has changed its nature and the channels through which it affects EMEs.

The paper is divided in five sections. Section 2 provides an overview of the changes of financial flows to EMEs, together with a periodisation for the regimes of financial internationalisation and globalisation from the 1970s to today. Section 3 establishes the relationship between the concepts of subordinated financial integration and currency hierarchy. Section 4 provides a synthetic balance sheet analysis for these different regimes to systematically assess the metamorphosis of external vulnerability that EMEs have been going through since then. Finally, Section 5 concludes.

## 2 New patterns of capital flows and cross-border stocks involving EMEs

### 2.1 Overall picture: Ever greater volumes, diversified channels and actors

Since the mid-1990s, there has been a remarkable and steady expansion in cross-border global capital flows in the world and consequently of cross-border stocks. EMEs still account for a small, albeit growing share of these stocks (Figure 1). However, despite the residual nature of capital flows directed to these economies, their potentially destabilising effects on their financial markets and exchange rates are significant, since the volume allocated by global investors is not marginal in relation to the size of these markets. This financial asymmetry stems from that fact that international financial integration takes place between ‘unequal partners’ (Studart, 2006).

**Figure 1. Global external assets (left) and external liabilities (right)\* (US\$ billion)**

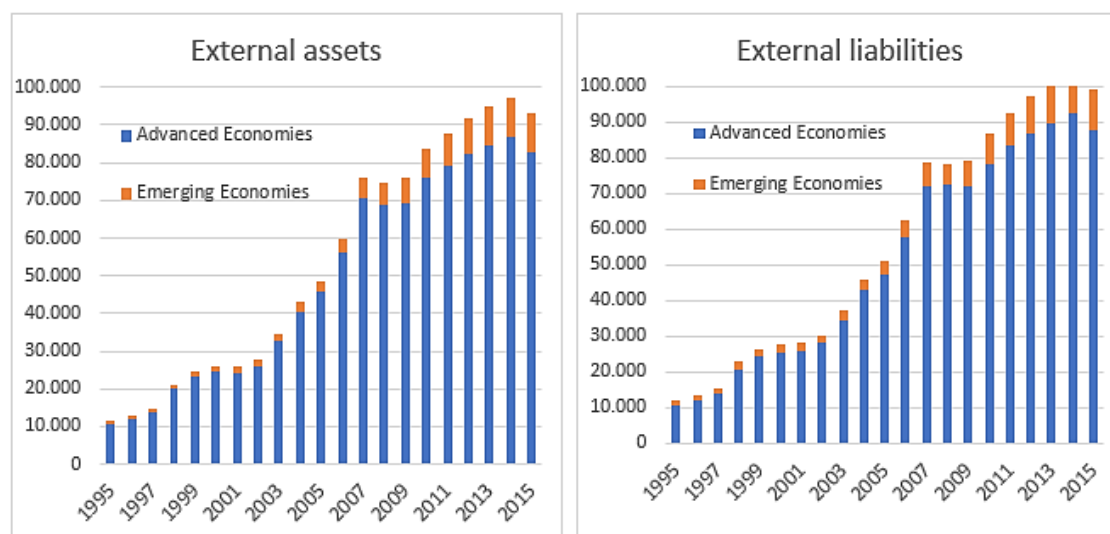

Source: Authors' elaboration with data from Lane and Milesi-Ferretti (2017).

Note: (\*) Major EMEs: Argentina, Brazil, China, Indonesia, India, Mexico, Poland, Thailand, Turkey and Russia; Major AEs: Australia, Canada, Euro Area, Japan, Korea, Switzerland, United Kingdom, United States and Taiwan

The value of EMEs' gross foreign assets and liabilities has significantly increased in absolute terms, and to a lesser extent as a proportion of GDP, being accompanied by

significant changes in the structure of external balance sheets (Figure 2). The unprecedented increase in foreign reserves – as a form of self-insurance to prevent a sudden reversal of speculative capital flows in EMEs – is the largest change on the asset side (more than 50% of total assets on average in 2004-2015, according to our calculations using data from Lane and Milesi-Ferretti, 2017). Foreign exchange reserve accumulation mostly originates from capital inflows, while only in a few countries is this the result of cumulative current account surpluses. At the same time, foreign direct investment (FDI) increased from 3.5% of GDP in 2000 to 7.8% in 2007 (17% of the total assets), thanks to the emergence of transnational firms in major EMEs such as Brazil, China, India, and Turkey. On the liability side, where the composition has been more diversified, the share of both FDI and equity portfolio has grown at the expense of other investments (where private external debt has been growing faster than public external debt), reducing their share from 45% in 1999 to 25.2% in 2015.

**Figure 2. External liabilities (left) and external assets to GDP (right): Major EMEs\* (percentage) – 1995-2015**

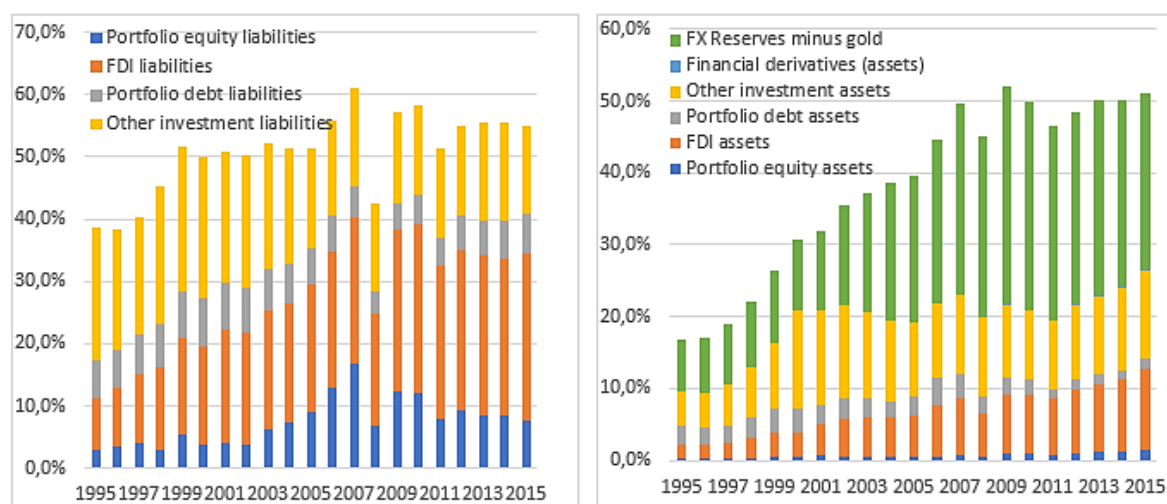

Source: Authors' elaboration with data from Lane and Milesi-Ferretti (2017).

Note: see Figure 1

Figure 3 shows the net external position of EMEs (without China, and only China): the composition of the net position is more or less similar, as both have a predominance of foreign reserves and FDI (which is still negative for both despite its growing participation in external assets). Only China has been a net creditor since 2000 due to its enormous foreign reserve accumulation, enabled by the combination of a currency account surplus and large FDI, while other EMEs have been net debtors (Figure 3).

**Figure 3. Net external position: Major EMEs\* (without China, left) and China (right) – as percentage of GDP – 1995-2015**

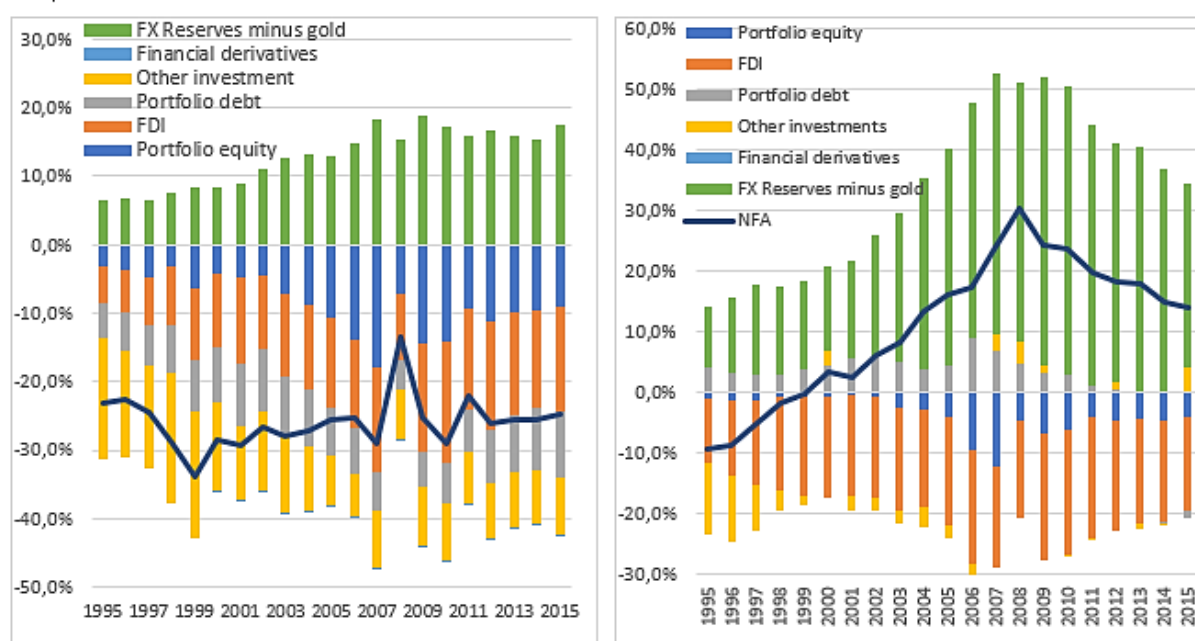

Source: Authors' elaboration with data from Lane and Milesi-Ferretti (2017).

(\* ) Argentina, Brazil, Indonesia, India, Mexico, Poland, Thailand, Turkey and Russia.

Note: Net external position = external assets minus external liabilities

Another new trend in the composition of several EMEs' external liability in the 2000s is the increasing proportion of public debt, denominated in domestic currency, held by non-residents. This is the case in most EMEs, accounting for more than 25% of total in Indonesia, Malaysia, Mexico, Peru, Philippines, Russia, South Africa and Turkey in 2013, according to Akyüz (2015, p. 41). A similar pattern has evolved in non-resident holdings in stock markets as a percentage of market capitalisation (Table 1).



**Table 1. Non-resident holdings in stock markets (% of market capitalisation)**

Country	2001	2007	2012
Argentina	1.4	5.7	8.2
Brazil	18.2	21.2	23.4
China	2.5	6.6	13.5
India	12.1	18.1	19.8
Indonesia	15.6	19.0	19.9
Malasya	10.5	20.8	17.0
Mexico	32.2	29.9	22.1
Phillippines	8.3	18.5	10.8
Russia	14.4	12.4	16.7
South Africa	9.3	10.2	19.7
Thailand	27.8	29.0	27.0
Turkey	9.4	17.0	20.2

Source: Azyuz (2015, p.22), World Bank WDI and IMF

The structural changes in the composition of cross-border holdings have amplified the susceptibility of gross external assets and liabilities and net foreign asset positions to variations in asset prices and exchange rates, entailing large transfers of wealth between EMEs and advanced economies (AEs). According to UNCTAD's (2019) estimates, in the 2000-2018 period the ensuing resource transfer from sixteen major EMEs amounted on average to roughly US\$ 440 billion per year or 2.2% of these countries' GDP, as a result of return differentials between safe external assets held to insure against risky external liabilities. Table 2 shows that the total returns of AEs were positive over 2000-2016, due to both the yield on gross assets and gross liabilities and the capital gains from changes in asset prices and exchange rates, while both were negative for EMEs. Hence, the EMEs negative returns on net international investment stems from not only the greater external liabilities than external assets for most countries, but also from the lower returns of their foreign assets compared with their foreign liabilities (see also Mayer, 2019).

**Table 2. Returns, yields and capital gains and losses of EMEs and AEs (percentage)**

	Yield*			Capital gains/Losses**			Total returns***		
	Assets	Liabilities	Differential	Assets	Liabilities	Total	Assets	Liabilities	Differential
<b>2000-2016</b>									
EMEs	3.1	5.7	-2.6	-1.0	-1.7	-2.7	2.1	7.4	-5.3
AEs	3.5	2.7	0.8	2.1	-1.3	0.8	5.6	4.0	1.6
<b>2000-2007</b>									
EMEs	3.3	5.9	-2.6	1.3	-5.3	-4.0	4.6	11.2	-6.6
AEs	4.3	3.4	0.9	4.9	-2.8	2.1	9.2	6.2	3.0
<b>2008-2016</b>									
EMEs	3.0	5.4	-2.4	-3.1	1.4	-1.7	-0.1	4.0	-4.1
AEs	2.8	2.0	0.8	-0.5	-0.1	-0.6	2.3	2.1	0.2

Source: Akyüz (2019, p. 66).

Note: (\*) Yields (dollar rates) on gross assets and on gross liabilities

(\*\*) Capital gains and losses result from changes in assets prices and exchange rates

(\*\*\*) Sum of yield and capital gains/losses

## 2.2 Financial internationalisation and globalisation: A periodisation of capital flow cycles to EMEs

The increasing volume of capital flows to EMEs and the resulting changes in the dimension and composition of their external liabilities and assets, as described above – together with the diversification of financial instruments and investors – has led to a growing internationalisation of finance in EMEs. This in turn is part of a broader global regime shift.

Regulationist economists (i.e. Guttman, 2016) define this new regime as “*finance-led capitalism*”. Its most important feature is the process of financialisation, broadly understood as a “pattern of accumulation in which profit making occurs increasingly through financial channels rather than through trade and commodity production” (Krippner, 2005, p. 173; see also Fontana *et al.*, 2019). Financial globalisation – defined as the interpenetration of national financial markets, as well as their integration in the international financial market (Chesnais, 1996, pp. 10-11) – is seen as one of the main drivers of ‘finance-led capitalism’ and financialisation.

Part of the mainstream literature sustains that this new era of financial globalisation promises more stability to the world economy due to a greater share of less volatile FDI and equity flows, even if volatile capital flows bring the risk of financial contagion (McKinsey, 2017). Against this, we argue in this paper that these structural changes have created new transmission channels of financial shocks through international capital flows and new sources of external vulnerability to EMEs (see section 4).

We can divide the boom-bust cycles of capital flows to EMEs into two main phases of financial internationalisation (1970s and 1980s) and financial globalisation (1990s to present). Financial internationalisation began in the 1970s with the increase in international commercial lending (mainly from “Eurodollar” markets), driven by a rapid expansion of international liquidity associated with oil surpluses and growing US external deficits, and it ended with an external debt crisis in Latin America in the 1980s<sup>3</sup>. The second period, financial globalisation, was triggered in the early-1990s by the rapid increase in liquidity and the huge decline in interest rates in the US and Japan, followed by a sovereign debt restructuring in Latin America and the capital account liberalisation of many EMEs.

Taking a closer look at the unfolding of financial globalisation and its impact in EMEs, we can identify three main sub-periods, the first of which started at the beginning of the 1990s and ended with a sequence of financial crises in Latin America, East Asia and Russia at the end of that decade. The second wave began with the new millennium, coming to an abrupt halt in 2008 with the GFC. Triggered by aggressive policies of quantitative easing by AEs central banks, a third cycle of financial globalisation started, with ever greater and diversified capital flows to EMEs. The inherent volatility of these

---

<sup>3</sup> The contraction of world trade in 1981 caused the prices of primary resources (Latin America's largest export) to fall. Considering the balance of payments of indebted countries due the effect of interest rate shocks on the stock of external debt, a handful of countries eventually became – using Minsky's (1986) taxonomy – Ponzi, namely they had to borrow to pay the debt service, in a situation that causes debt to escalate.

flows reached its peak in the months immediately after the outbreak of COVID-19 and its related global economic crisis.<sup>4</sup>

While debt operations (mainly bank loans) predominated during the cycle of financial internationalisation, the first cycle of financial globalisation began with some change in the composition of capital inflows, with a gradual increase in FDI. However, it is in the second and third capital flows' waves of financial globalisation that major changes occurred. Besides the much larger total flows, their composition became more diversified, favoured – among others – by carry-trade operations to explore interest differentials, the internationalisation of global value chains, the enormous push of FDI to and from China, and the liberalisation of local capital markets to foreign investors (see Figure 4; for an overview over the different periods see also Table A1).

---

<sup>4</sup> This sequencing obviously entails regional and country-specific variation, which we cannot detail due to space constraints. Here, the group of so-called 'frontier markets' of Sub-Saharan African and other poorer countries in terms of per capita income (IMF, 2019) certainly represents one of the major variations. These only entered into financial globalisation after the 1990s or the 2000s, and to date they demonstrate a lower and less complex degree of global financial integration.

**Figure 4. External liabilities of major emerging economies\* – 1970-1994 (a) and 1995-2015 (b) (US\$ billion)**

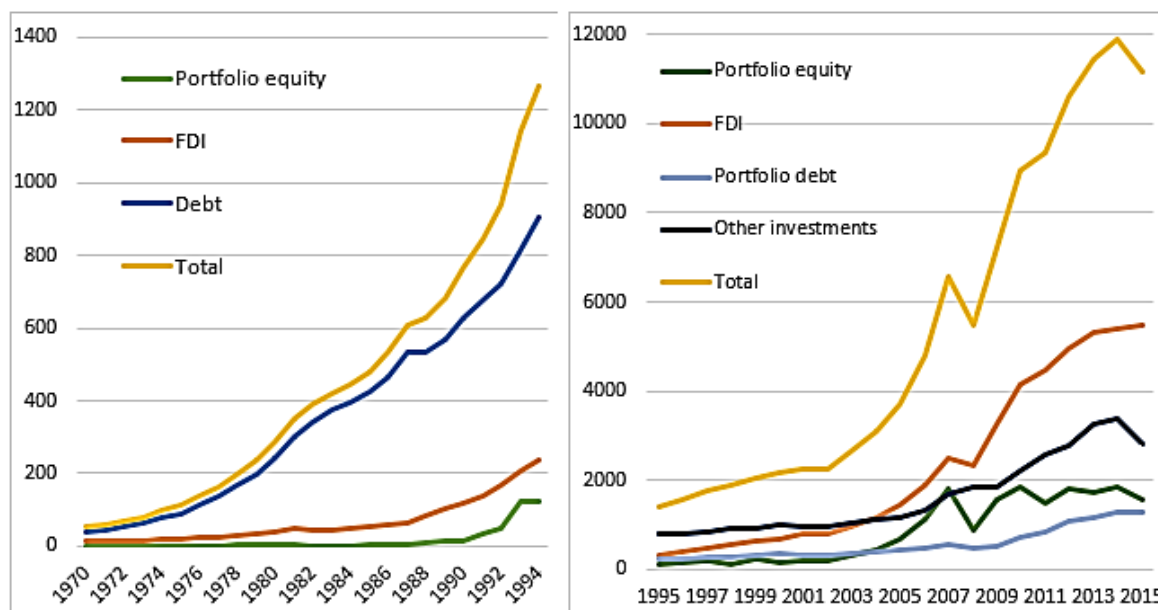

Source: Authors' elaboration with data from Lane and Milesi-Ferretti (2017).

Note: (i) Major emerging economies: Argentina, Brazil, China, Indonesia, India, Mexico, Poland, Thailand, Turkey and Russia; (ii) On the left graph: debt = other investments plus portfolio debt.

### 2.3 Capital flows under COVID-19

The COVID-19 pandemic led to the burst of the third wave of capital flows under financial globalisation. The high uncertainty related to the spread of the pandemic hugely increased fears about the future, triggering unprecedented portfolio outflows from EMEs, first reaching equity markets and in the sequence bond markets, resulting in deflation in equity prices, a sharp increase in bond spreads and abrupt currency depreciations. Net outflows amounted US\$ 104.8 during the COVID-19 crisis, more than three times the US\$ 33.0 billion recorded in the GFC (Figure 5). However, since April 2020, this movement lost momentum with the partial recovery of portfolio capital inflows to EMEs, which has led to prices of many assets returning close to the levels that they held prior to the panic sell-off (Wheatly, 2020). As central banks of major AEs have unleashed

unprecedented amounts of liquidity in response to the recent crisis, global investors have had little choice but to search yield in EMEs.

**Figure 5. Net portfolio outflows from selected EMEs\* – US\$ billion (left) and exchange rate (US\$/local currency; 100 = 2 Jan.), January-August 2020 (right)**

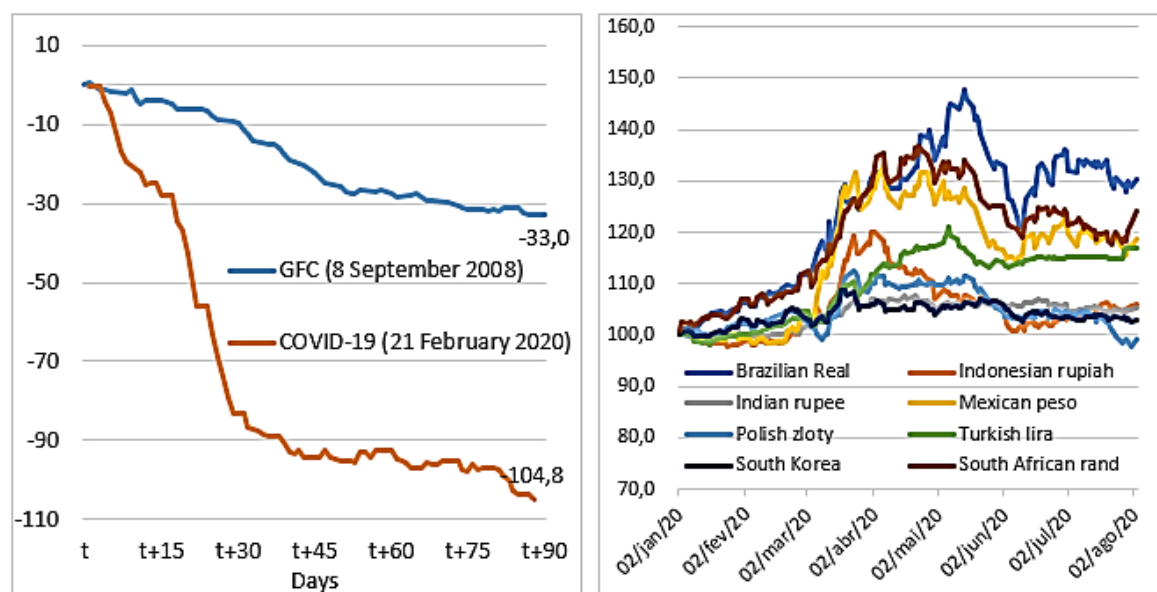

Source: UNCTAD secretariat calculations based on IFF Daily Emerging Market Portfolio database

(\*) Selected: Brazil, China, India, Indonesia, Mexico, Pakistan, Philippines, Qatar Republic of Korea, Saudi Arabia, Sri Lanka, South Africa, Thailand, Turkey, and Vietnam.

One determinant of the record capital outflows from EMEs during COVID-19 crisis is the increasing importance of benchmark-driven funds – that follow a flagship benchmark index with a predefined list of countries and securities with specific weights (JP Morgan EMBI or Morgan Stanley’s MSCI) – which are much more strongly influenced by push factors: the behaviour of these funds contributed to the strong correlation across asset managers’ portfolio decisions during the COVID-19 crisis, reinforcing the herding behaviour of investors that is typical in such circumstances.

The combination of the COVID-19 crisis and the steep decline in oil prices led to sharp currency depreciation in EMEs between the end of February and mid/late-March 2020, in a trend that continued in April in some countries like Brazil, South Africa and Turkey

more than in others<sup>5</sup> (Figure 4). The greater presence of foreign investors in local capital markets has increased the transmission of international financial shocks to these markets, as surges in the entry and exit of non-residents affect not only asset prices but also exchange rates. Indeed, huge currency depreciations have a strong impact on EMEs. First, as most EMEs accumulated corporate external debt prior to the COVID-19 crisis, driven by historically-low borrowing costs and various incentives favouring debt over equity, free-falling exchange rates along with a sharp rise in spreads have increased the costs to borrowers paying foreign currency debt (OECD, 2020). Second, the reduction of financial assets' values in foreign investors' home currency terms eventually triggered the sale of financial assets by non-residents, which resulted in further capital outflows (Hofmann *et al.*, 2020). This latter event is related to the emergence of a new source of external vulnerability – the so-called ‘original sin redux’ – which we will analyse in section 4.

---

<sup>5</sup> Hannan (2018, p.13-14) provides a clue for understanding the different EMEs reactions to an external financial shock: “The more recent work shows that while the incidence of capital flow surges depends on external factors, whether a particular emerging market economy receives that surge depends on domestic factors, including the extent of financial market liberalisation and global financial market integration.”

### **3 Currency hierarchy and the subordinated financial integration of EMEs**

Critical discussion regarding the effects of financial globalisation on EMEs – in particular related to the more recent boom-bust cycles – comes from diverse strands. Especially relevant are the concepts of centre-periphery, currency hierarchy and subordinated finance, which result in global asymmetries. EMEs’ ‘subordinated financial integration’ is the form of insertion of peripheral countries in global finance, and the way in which global finance and domestic economies are connected, whereby “not only is financialisation fundamentally shaped by EMEs subordinated position within the international financial economy, but also that financialisation itself cements this position and exacerbates uneven development” (Kaltenbrunner and Paineira, 2017, p. 304). This calls for a discussion about international monetary asymmetry, as EMEs that issue what we call peripheral currencies (i.e. currencies that are not accepted at the international level) have a subordinated insertion in the international monetary system (see also Ocampo 2001).

In this vein, in other works (Paula *et al.*, 2017; Fritz *et al.*, 2018; see also Andrade and Prates, 2014) we have applied the structuralist concept of an asymmetric global economy divided into two poles – centre and periphery – to the analysis of the international monetary system. This approach states that currencies are hierarchically positioned according to their degree of liquidity, whereby the key currency (currently the US fiduciary dollar) is placed at the top of the hierarchy because it has the highest degree of liquidity. The currencies issued by the other centre (or advanced) countries/regions (such as the euro and yen) are in intermediate positions and they are also liquid currencies. At the opposite end are the currencies issued by peripheral economies, which are non-liquid currencies as they are incapable of performing the basic functions of money (medium of exchange, denomination of contracts and international reserve currency) at the international level.

Indeed, with its formalisation of the liquidity premium in relation to other valuation attributes of assets, the concept of currency hierarchy enables more precisely capturing the effects of financial globalisation in EMEs, especially in the recent cycles.



To compensate the differences in liquidity premia between centre and periphery assets, less liquid currencies need to offer higher total returns to be attractive to international investors, such as higher interest rates and/or higher capital gains (through asset price and/or exchange rate appreciation) when compared with AEs' currencies. Expressed formally, in the face of the lower liquidity premium ( $l$ ), to make a global investor hold their assets, EMEs have to offer higher monetary returns ( $a + q$ ) – where  $a$  is the expected appreciation/depreciation of the currency and  $q$  is the yield of the securities (measured by the interest rate) – and/or reduce the carrying cost by reducing regulation on the capital account ( $c$ ). In equilibrium, we have:

$$a_N + q_N - c_N + l_N = a_S + q_S - c_S + l_S \quad (1)$$

where  $S$  denotes Southern or EMEs, and  $N$  denotes Northern or AEs.

As  $l_S < l_N$ , this difference has to be compensated by higher returns, so that:

$$(a_S + q_S - c_S) > (a_N + q_N - c_N) \quad (2)$$

Taking account of the recent changes in the composition of capital flows with the increasing share of portfolio debt and equity in external liabilities, we additionally consider the valuation variation generated by changes not only in exchange rates but also in asset prices (equities, bonds).

Therefore, we extend the formal concept of currency hierarchy (formula (1)) by incorporating the yield differentials and assets' capital gains/losses, so that:

$$l_S < l_N \Rightarrow (a_{c:S} + a_{a:S} + q_{r:S} + q_{y,S} - c_S) > (a_{c:N} + a_{a:N} + q_{r:N} + q_{y,N} - c_N) \quad (3)$$

where  $a_c$  is currency appreciation/depreciation,  $a_a$  is asset price appreciation/depreciation,  $q_r$  is the monetary returns derived from loans' interest rates and  $q_y$  is the yield derived from fixed income securities (portfolio debt).

To better understand how the different liquidity premia shape foreign investors' portfolio decisions along boom-bust cycles, we bring in Minsky's (1986) financial fragility hypothesis. He emphasises the inherent tendency over economic units to move from the

state of robustness to financial fragility over time, “due to shift in expectations that occurs over the course of a business cycle, and the way this shift is transmitted through the financial system” (Dymski and Pollin, 1992, p. 40). This behaviour results in the adoption of increasingly smaller safety margins, giving rise to a growing financial fragility in the economy. To cite Minsky’s (1982, p. 101) most well-known aphorism: “*Stability – or tranquillity – in a world with a cyclical past and capitalist financial institutions is destabilising*” (italics added).

During *booms* of capital inflows – i.e. stability and tranquillity – in the international financial markets (most of them geared initially by an expansionary monetary policy in the United States), global investors’ preference for liquidity decreases, leading to a fall in the weight given to the liquidity premium differential and a rise in global investors’ demand for EMEs securities, associated with the favourable interest rate differential (bonds) or expectation of capital gains (equity) in local markets (see formula 3 above)<sup>6</sup>. This ‘search for yields’ results in an appreciation of the emerging currency, leading to an expectation of further appreciation (rise in  $a$ ), which further increases the expected return differential, thus further stimulating capital inflows and reinforcing the currency appreciation.

Two features of EMEs underlie these self-feeding interactions that increase the financial fragility over the boom and can lead to destabilising dynamics in the bust phase. First, these investors are more likely to be drawn to exchange rate returns that are greater for EMEs’ currencies due their higher volatility, stemming from their subordinated position in the currency hierarchy. Consequently, they tend to respond more quickly to a first exchange rate appreciation. Second, the demand from a few money managers is sufficient to trigger self-feeding interactions due to the already-mentioned financial asymmetry.

Over the boom phase, the continuity of investors’ low liquidity preference leads to a sustained and gradual increase in the demand for EMEs assets and hence a gradual currency appreciation path. Conversely, over the bust phases, by virtue of changes in the

---

<sup>6</sup> For a formalisation of the relationship between liquidity preference and liquidity premium, see Ramos (2019).

monetary policy in the AEs and/or an increase in the international liquidity preference, sudden capital outflows trigger deflation of EMEs' financial assets and an abrupt depreciation of EMEs' currencies, which are the main victims of global investors' 'flight to quality'(Ramos, 2019; see also Paula et al., 2017).

## **4 The metamorphosis of external vulnerabilities: A balance sheet analysis**

This section aims to present stylised balance sheets of EMEs for the periods of both financial internationalisation and financial globalisation. This will allow us to systematically assess how these economies' vulnerability to external financial shocks has changed over time (see Table A1 in the Annex for a summary).

For this purpose, we consider the changes in the nature of cross-border financial flows involving EMEs that shape the profile of their net external position, as described in section 2. These changes stem from a set of factors – such as the level of financial liberalisation, the characteristics and degree of complexity of financial instruments, the actors involved, and the links between the domestic and international financial sectors – that create diverse transmission channels of external shocks. We will use the notion of subordinated financialisation and our extended concept of currency hierarchy to analytically distinguish the building up and the unfolding of external vulnerabilities (see section 3). Our use of balance sheets to grasp the metamorphosis of these vulnerabilities in EMEs is also inspired by Minsky's framework for agents' portfolio decisions and their balance sheets.

### **4.1 Traditional vulnerability under conditions of financial internationalisation: Balance sheet effects from original sin**

During the period considered here (1970s-1980s), the term 'emerging economies' did not even exist, as developing countries (the dominant general term for peripheral countries then) adopted significant restrictions on capital flows in this period, except for FDI and external loans. Back then, external debt mainly entered in the form of syndicate loans of Northern universal banks operating in the Euromarket and FDI<sup>7</sup>, with floating interest

---

<sup>7</sup> For the sake of simplification, we only assess financial flows, and do not consider FDI. Against the neoclassical conception of households, here we distinguish between private households as wage earners without net financial richness, and investors who are net wealth owners.

rates, long maturity and being denominated in Northern currency (\$N), i.e. USD (see arrow (1) in Figure 6 below). This phenomenon of foreign currency-denominated debt has been labelled as ‘*original sin*’ (Eichengreen *et al.*, 2002), reflecting the inability of an economy to borrow abroad in one’s own currency. The borrowers could be Southern banks, which would pass on lending to domestic firms (often in Southern currency (\$S), arrow (2)), but in some cases also in or denominated in N\$, or they could be domestic firms directly (arrow (3)).

As in Southern economies  $c_S$  was high and constant in this period due to non-liberalised capital accounts, and  $a_S$  was stable due to the dominance of fixed exchange rate regimes, international creditors’ motivation concentrated on the yield differential ( $q_S - q_N$ ), which had to compensate the liquidity premium differential ( $l_N - l_S$ ), whose weight given by them in their portfolio decisions decreased due to the lower liquidity preference during the boom.

This first post-war capital flow cycle lost speed with mounting debt levels in developing countries, especially in Latin America, although the death knell came with the interest rate shock by the Fed in 1979, which led to an increase in  $q_N$ . The subsequent rise in the liquidity preference of international creditors triggered a credit crunch in the syndicated loan markets. Sovereigns, domestic banks, state-owned and private firms came under liquidity stress, as a consequence of maturity mismatch from the shortening of lending terms, interest rate increases and the impact of currency devaluation.

The key vulnerability to a global financial shock for countries tainted with ‘*original sin*’ is that the Southern central bank has a truncated capacity to act as a lender of last resort (LLR) for solvent domestic banks indebted in \$N. While the central bank can act as an LLR for domestic financial institutions in its own currency – as pointed out by Bagehot’s (1873) seminal work (arrow (4)) – the central bank’s LLR capacity in \$N is limited to its foreign reserves. This inability to handle \$N-related liquidity problems triggers a shift from liquidity to solvency problems in the domestic financial and productive sectors.

At the moment when the burden of external debt grows abruptly due to an external shock, the level of foreign exchange reserves may prove to be insufficient to maintain the balance of payments in equilibrium. This in turn may lead to exchange rate devaluation, i.e. a

currency crisis given the fix or semi-fix exchange rate regimes. Such a crisis is even more probable if illegal capital flights from Southern investors (arrow (5)) place additional pressure on these reserves. In the face of high uncertainty and cumulative devaluation expectations, the yield differential ( $q_S - q_N$ ) is no longer sufficient to compensate the liquidity premium differential ( $l_N - l_S$ ), whereby these Southern wealth owners also wish to switch to \$N.

**Figure 6. Balance sheet of Southern country under financial internationalisation**

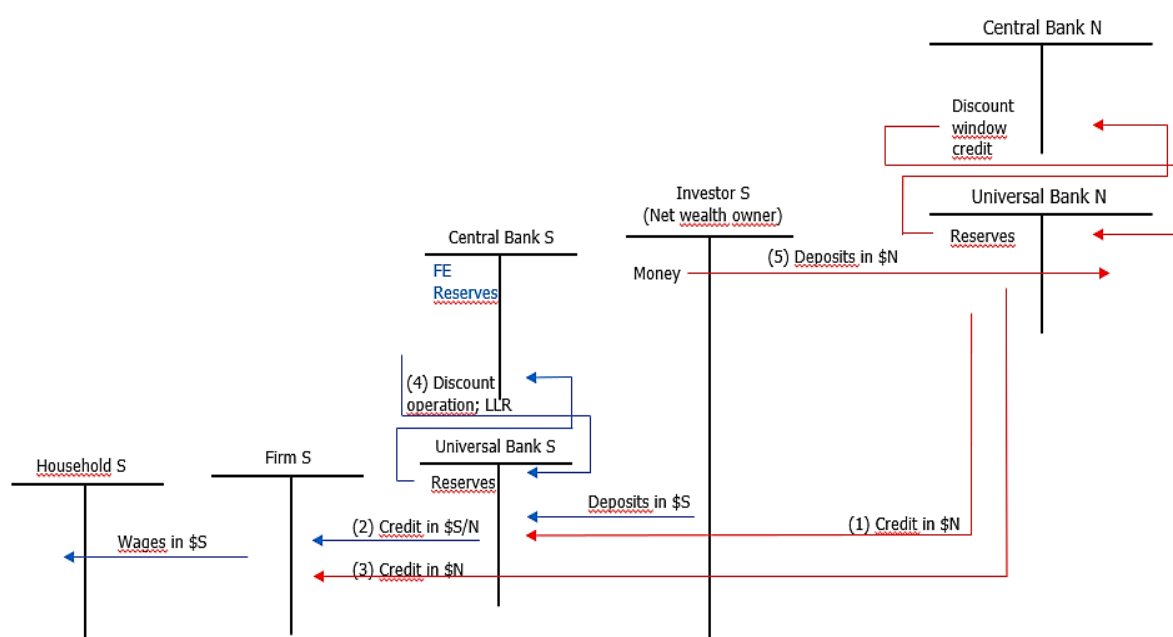

Source: Authors' elaboration, adapted from Nitsch (1999) and Bindseil (2004).

Notes: LLR = Lender of last resort; blue: domestic transactions; red: cross-border transactions; arrow direction: creditor to debtor.

## 4.2 Increased interconnectedness and new vulnerabilities under financial globalisation: 'Original sin redux'

Most EMEs entered the 1990s opening their capital accounts ( $c_s \downarrow$ ) for inflows and outflows, in a process that would gradually continue over the next two decades. This came together with a shift to flexible exchange rate in the 2000s, the second sub-period of financial globalisation. All three capital flow cycles of financial globalisation were driven by periods of low global interest rates. However, especially the third sub-period of

quantitative easing during the 2010s – and recently during the COVID-19 crisis – launched an intensified global ‘search for yield’.

The interconnectedness with international financial markets has become much more intensive, diverse and complex (see Figure 7 below). The share of cross-border activities increased with the emergence of new agents and diversified and complex financial instruments such as derivatives, especially from the 2000s onwards.<sup>8</sup> All kinds of wealth owners (i.e. institutional investors or money managers, from pension funds to hedge funds) emerged in Northern as well as Southern countries, and Southern treasuries entered the field as borrowers with cross-border links with these investors.

During boom periods of international capital flows to EMEs, the Southern firm has continued to borrow in  $\$N$  from Northern banks (arrow (1)), and partially also from banks in their own country (arrow (2)). This is the same pattern as during financial internationalisation, albeit at a higher level, especially during the latest sub-period, due to a record-low  $q_{rN}$ . New to this period is the issuing of securities by Southern banks and firms (in  $\$N$  in the international capital market and in  $\$S$  or  $\$N$  in the domestic market, arrow (6)). Moreover, the Southern firm has become financialised (Bonizzi *et al.*, 2019), investing in financial assets in  $\$N$  and  $\$S$  (arrows (8) and (10)). As a result, the typical Southern firm has seen the two sides of its balance sheet boosted during the tranquillity phase: the asset price inflation would increase the value of its assets ( $a_{aN}\uparrow$ ; and  $a_{aS}\uparrow$ ; see formula (3) in section 3). This would enhance its capacity of borrowing in  $\$N$  and  $\$S$ , hence pushing up the value of its liabilities.

The idealised Northern investor has invested in EMEs in securities in  $\$N$  and  $\$S$  in the international and domestic financial markets (arrow (6)). Moreover, it receives investment from Southern investors (arrow (7)) and Southern firms (arrow (8)) both in

---

<sup>8</sup> The balance sheet analysis in this section supposes an emerging economy with full capital account openness and permission for domestic financial transactions in (or denominated in)  $\$N$ . For the sake of simplicity, it only includes transactions in spot markets, thus excluding derivatives, for example.

\$N. The Southern treasury has issued bonds in \$N, and increasingly also in \$\$, both to be increasingly held by international investors (arrow (9)).

While busts of capital flows to EMEs are often associated with a  $q_{rN} \uparrow$ , the global financial crisis – and especially the latest bust of the COVID-19 global shock – were triggered by a radical increase in uncertainty, resulting in a sharp rise in the liquidity preference of Northern agents and the weight given to the liquidity premium differential ( $l_N - l_S$ ). When looking at the more recent bust periods – and especially the COVID-19 sudden stop – we detect a much more complex pattern of balance sheet effects.

For cross-border debt in \$N, we essentially detect the same kind of negative balance sheet effects due to ‘original sin’ and the limited capacity of the Southern central bank to act as an LLR (arrow (4)) as in the period of financial internationalisation. Again, Southern debtors in \$N suffer from the problem of debt revaluation expressed in Southern currency due to currency depreciation, which eventually leads to a situation of insolvency. However, the level of complexity attached to these negative balance sheet effects has significantly increased. While these were previously limited to Northern banks and Southern banks and firms indebted in \$N, now they affect nearly all sectors of the Southern economy, including the public sector. This new complexity of currency mismatches creates liquidity problems all over the economy and further reinforces currency depreciation and financial instability in the case of a sudden stop. Economic literature started to grasp the nature and explosive implications of this kind of balance mismatches after the series of financial crises in EMEs in Asia and Latin America (i.e. Calvo *et al.*, 2004).



**Figure 7. Balance sheet of Southern country under financial globalisation**

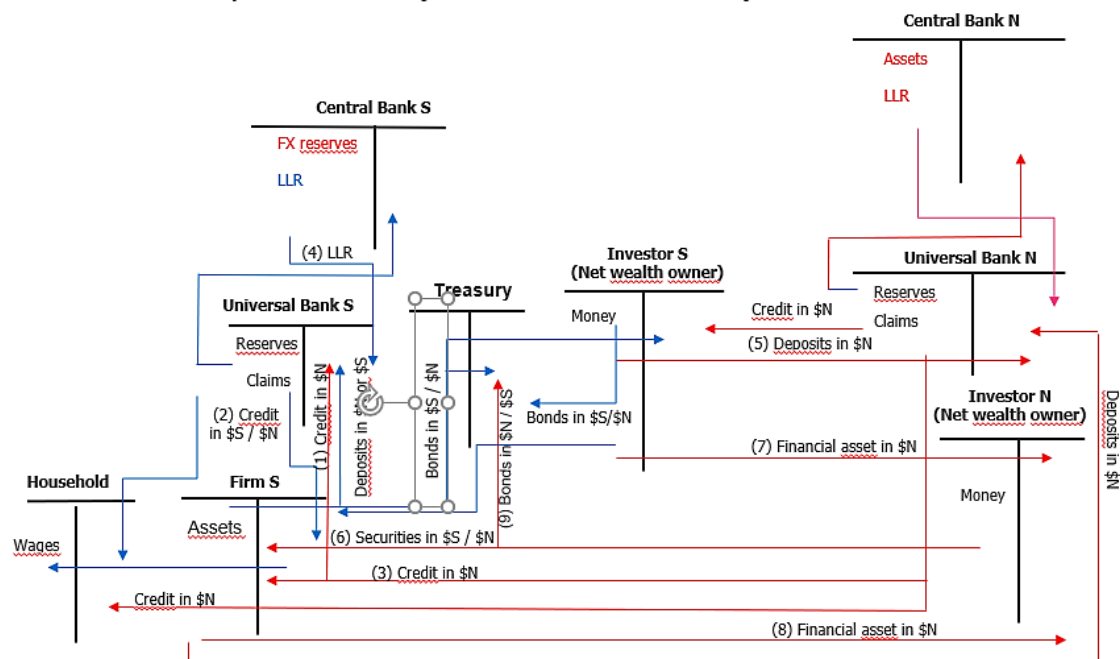

Source: Authors' elaboration loosely inspired on Bindseil (2004) and Nitsch (1999)  
 Notes: LLR = lender of last resort; blue: domestic transactions; red: cross-border transactions; arrow direction: creditor to debtor.

In view of this, the increased investment of global investors in securities in \$S appears to be very good news, as it shifts the balance sheet effects of a currency depreciation from Southern borrowers to Northern creditors. Consequently, EMEs' exposure to this kind of external vulnerability declines. The Southern treasury, for example, remains isolated from the direct effects of a currency depreciation when its bonds in \$S are held by global investors, with the latter recording losses, measured in \$N.

However, this new pattern of EMEs' liabilities held by global investors creates new channels of transmission of financial shocks, and with this a new source of external vulnerability. To date, such a new phenomenon has remained rather unperceived in academic work and policy guidance, to our knowledge.

'Original sin redux' is the term coined by economists of the Bank for International Settlement (BIS) (Carsten and Shin, 2019; Hofmann *et al.*, 2020) to grasp this new type of vulnerability. The authors stress that as foreign investors have assets in EMEs'

currencies but obligations to beneficiaries in their own currency (\$N), an EME's currency depreciation might trigger sales of EMEs' bonds and equity.

“The exchange rate plays an important amplifying role in the portfolio adjustment of global investors [lending in EMEs currencies] (...). In this context, a generalized EME currency depreciation further lowers the value of assets in the foreign investors' home currency terms, tightening their risk constraints more than otherwise. When risk capacity is limited, EME currency depreciation may trigger sales or ex post hedging, pushing up EME bond spreads due to the exit of foreign investors” (Hofmann *et al.*, 2020, p. 2).

Thus, even if Northern investors have to bear the direct costs of an  $a_{cS}$  decrease, their reaction will trigger self-feeding interactions in the opposite direction to that observed in the boom phase (see section 3), i.e. further capital outflows to cover prior losses, reinforcing  $a_{cS}$  devaluation. The reaction to these effects due to ‘original sin redux’ will thus increase the balance sheet effects linked to the ‘original sin’ of Southern debtors in \$N.

This multiplied herding behaviour of investors who originally invested in different currencies and assets but reacted to shocks in the same direction augments the volatility of capital flows and EME exchange rates and financial asset prices, therefore influencing the transfers of wealth between EMEs and AEs. While for specific agents the net costs will depend on a series of variables such as the ratio of debt held in \$\$ to that in \$N and the net effects of asset price changes on the share of each currency on his/her asset and liability sides, for the EME economy as a whole the result is augmented capital flow and exchange rate volatility, with all of its damaging effects for growth, employment and productive investment.

## 5 Conclusion

In this paper, we have asked how new patterns of capital flows and cross-border stocks under financialisation and financial globalisation influence the external vulnerability of EMEs, considering their subordinated form of integration in global financial markets. We departed from the Keynesian-structuralist idea of an asymmetric configuration of the global monetary system, formalised in a concept of currency hierarchy that is shaped by the difference in the liquidity premia attributed to currencies of the centre (Northern) and peripheral (Southern) countries. We then extended this formal concept to theoretically grasp the increased relevance of portfolio flows and global investment in EMEs' currencies that we identify.

Our balance sheet analysis inspired by Minsky's framework is based on an idealised EME, with its capital account nowadays fully open to all kinds of financial operations by domestic and international agents in the period of financial globalisation. This allows us to systematically assess the metamorphosis of these vulnerabilities. For the period of financial internationalisation, we identify as the main vulnerability the negative effects of the so-called 'original sin' in the balance sheet of Southern agents indebted in Northern currency. The resulting currency mismatch leads to a revaluation of their debt in domestic currency in the case of an external shock with a currency devaluation. On the one hand, 'original sin' effects have augmented in the period of financial globalisation, with increased debt volumes and financial sophistication.

On the other hand, these effects of 'original sin' have not been eradicated, but contained by increasing global investment also in securities denominated in EMEs' currencies. Indeed, due to having liabilities in Northern currencies and assets in Northern and Southern currencies, now Northern investors' balance sheets are tainted by potential currency mismatches. Here, it is those investors who suffer the losses from EMEs' currency depreciation. These will be greater, the longer the period of tranquillity and build-up of financial fragility. In theory, this should thus reduce EMEs' external vulnerability. However, what we found is that this has created new sources of external vulnerability, which economists from the BIS recently labelled as 'original sin redux'.

This also helps us to better grasp the new and complex vulnerabilities of EMEs that the current COVID-19 crisis has brought to light. Radical uncertainty in the first weeks – and with this a sharp increase in the liquidity preference of global investors – led to an unprecedented sudden stop and capital outflow of EMEs, followed by a quick – even if partial and selective – rebounding of capital flows, linked to aggressive quantitative easing in the North and the subsequent decline in the liquidity preference at the international level.

Our explanation based on our balance sheet analysis is twofold: first, the wave of new debt accumulation in the latest sub-period of financial globalisation – together with new investment strategies such as the benchmark-driven management of EMEs funds – further increased problems of ‘original sin’ and with it global investors’ herding behaviour. Second, ‘original sin redux’ further pushed capital outflows, as international investors were running from dropping asset prices in Southern domestic financial markets, exerting even stronger pressure on EMEs’ exchange rates. However, when asset prices reached record lows, these investors with their recovered hunger for yields gradually returned to investing in EMEs’ assets denominated in both Northern and Southern currencies.

The new pattern of vulnerabilities has thus created an unprecedented level of complexity, where it becomes more and more difficult to foresee gains and losses for agents in global markets in periods of global turmoil, and where reactions to shocks turn increasingly brusque, exposing EMEs to ever higher volatility of capital flows and exchange rate variations, with all of its damaging effects for growth and sustainable development.

In terms of policy lessons, this brings two issues to the table: first, concerning which indicators policy-makers need to grasp these new complex vulnerabilities; and second, the necessity of containing the adverse impacts of financial globalisation, with instruments such as comprehensive capital account regulation.

With our contribution, we also seek to open up new fields for research. This may be quantitative analysis to better grasp the effects of ‘original sin redux’. Also, there are relevant differences among EMEs regarding their form of subordinated integration into global financial markets, which have been disregarded here but are highly relevant, and which require careful case studies to assess the relative weight of the old and new external

vulnerabilities and their entanglement. Finally, the idealised balance sheets that we have presented here might serve as an analytical tool for the new complex distribution of gains and losses across borders and the resulting wealth transfers, as well as their cumulative effects for EMEs in periods of global turmoil.

## References

Akyüz, Y. 2011. ‘Capital flows to developing countries in a historical perspective: Will the current boom end with a bust?’, *South Centre Research Paper* no. 37, March

Akyüz, Y. 2015. ‘Internationalization of finance and changing vulnerabilities in emerging and developing economies’, *South Centre Research Paper* no. 60, January

Akyüz, Y. 2019. ‘External balance sheets of emerging economies: Low-yielding assets, high-yielding liabilities’, *PERI Working Papers Series* no. 475, April

Bagehot, W. 1873. *Lombard Street: A Description of the Money Market*, London, Henry S. King and Co.

Bindseil, U. 2004. *Monetary Policy Implementation. Theory, Past and Present*, Oxford, Oxford University Press

Bonnizi, B., Kaltenbrunner, A. and Powell, J. 2019. ‘Subordinate financialization in emerging capitalist economies’, *Greenwich Papers in Political Economy GPERC69*

[Calvo](#), G., [Izquierdo](#), A. and [Mejia](#) L.F. 2004. ‘On the empirics of sudden stops: The relevance of balance-sheet effects’, *NBER Working Paper* No. 10520

Carstens, A. and Shin, H.S. 2019. ‘Emerging markets aren’t out of the woods yet’. *Foreign Affairs*, March 15

Chesnais, F. 1996. ‘Introduction Générale.’ In *La Mondialisation Financière: Genèse, Coût et Enjeux*, ed. Chesnais, F. Paris, Syros

Dymski, G. and Pollin, R. 1992. ‘Hyman Minsky as hedgehog: The power of the Wall Street paradigm’. In Fazzari, S. and Papadimitriou, D. (ed.), *Financial Conditions and Macroeconomic Performance*. Armonk, M.E. Sharpe

Eichengreen, B., Hausmann, R., and Panizza, U., 2002. ‘Original sin: The pain, the mystery and the road to redemption’, paper presented at a conference on Currency and

Maturity Matchmaking: Redeeming Debt from Original Sin, Inter-American Development Bank

Fontana, G., Pitelis, C. and Runde, J. 2019. 'Financialisation and the new capitalism?', *Cambridge Journal of Economics*, vol. 43, no. 4, 799–804, <https://doi.org/10.1093/cje/bez029>

Fritz, B., Prates, D. and Paula, L.F. 2018. 'Global currency hierarchy and policy space: A framework for peripheral economies', *Intervention: European Journal of Economics and Economic Policies*, vol. 15, no. 2, 208-218

Guttman, R. 2016. *Finance Led Capitalism: Shadow Banking, Re-regulation, and the Future of Global Markets*, Basingstoke, Palgrave MacMillan

Hannan, S.A. 2018. 'Revisiting the determinants of capital flows to emerging markets—A survey of the evolving literature', *IMF Working Paper WP/18/214*, September

Hofmann, B., Shim, I. and Shin, H.S. 2020. 'Emerging market economy exchange rates and local currency bond markets amid the COVID-19 pandemic', *BIS Bulletin* no. 5, April

IMF 2000. *Debt- and Reserve-Related Indicators of External Vulnerability*. <https://www.imf.org/external/np/pdr/debtres/>

IMF 2019. Global Financial Stability Report, October. Available at: <https://www.imf.org/en/Publications/GFSR/Issues/2019/10/01/global-financial-stability-report-october-2019>

Kaltenbrunner, A. and Painsera, J.P. 2017. 'Subordinated financial integration and financialisation in emerging capitalist economies: The Brazilian experience', *New Political Economy*, <https://doi.org/10.1080/13563467.2017.1349089>

Krippner, G. 2005. 'The financialization of the American economy', *Socio-Economic Review* vol. 3, 173-208, <https://doi.org/10.1093/SER/mwi008>

- Lane, P.R. and Milesi-Ferretti, G.M. 2017. 'International financial integration in the aftermath of the global financial crisis', *IMF Working Paper* WP/17/115, May
- Mayer, J. 2019. 'Returns on external balance sheets and the currency hierarchy', unpublished manuscript
- McKinsey 2017. *The New Dynamics of Financial Globalization*, Washington, McKinsey Global Institute
- Minsky, H. 1982. *Can 'It' Happen Again?* Armonk, NY, M.E. Sharpe
- Minsky, H. 1986. *Stabilizing an Unstable Economy*, Yale, Yale University Press
- Nitsch, M. 1999. [Vom Nutzen des monetär-keynesianischen Ansatzes für Entwicklungstheorie und -politik](#), in: Schubert, R. (Hg.): *Neue Wachstums- und Außenhandelstheorie*. Berlin, Duncker & Humblot
- Ocampo, J.A. 2001. 'International asymmetries and the design of the international financial system', *CEPAL Serie Temas de Coyuntura* n. 15, Santiago de Chile: CEPAL
- OECD 2020. 'Covid-19 and global capital flows', available at [https://read.oecd-ilibrary.org/view/?ref=134\\_134881-twep75dnkt&title=COVID-19-and-global-capital-flows](https://read.oecd-ilibrary.org/view/?ref=134_134881-twep75dnkt&title=COVID-19-and-global-capital-flows), (accessed 13 August 2020)
- Paula, L.F., Fritz, B. and Prates, D. 2017. 'Keynes at the periphery: Currency hierarchy and challenges for economic policy in emerging economies', *Journal of Post Keynesian Economics*, vol. 40, no. 2, 183-202, <https://doi.org/10.1080/01603477.2016.1252267>
- Ramos, R.A. 2019. 'A Minskyan account of emerging currencies dynamics', *Journal of Post Keynesian Economics*, vol. 42, no. 4, 638-661, <https://doi.org/10.1080/01603477.2019.1640066>
- Stiglitz, J., and Ocampo, J.A. (Eds.). 2008. *Capital Market Liberalization and Development*, Oxford/New York, Oxford University Press



Studart, R. 2006. 'Integrating uneven partners: The destabilizing effects of financial liberalization and internationalization of Latin American economies.' In Vernengo, M. (ed.), *Money Integration and Dollarization*. Cheltenham, Edward Elgar

UNCTAD 2019. 'Managing capital inflows to reduce resource transfer from developing to developed countries', *Policy Brief* no. 17, December

Wheatly, J. 2020. 'Fundamentals matter again for emerging market investors', *Financial Times*, 26 August

World Bank 2020. *World Bank Open Data by Indicator*, available at <https://data.worldbank.org/indicator>, (accessed 04 April 2020)

**Table A1. Phases of the metamorphosis of external vulnerabilities**

Features	Financial internationalization (1970-80s)	Financial globalization		
		1990s	2000s to GFC	Post-GFC to 2020
<b>Stage of financial liberalization in EME</b>	Low	Liberalization ↑↑	Liberalization ↑	Liberalization ↑
<b>Exchange rate regime</b>	Fix, but adjustable	Fix/semi-fix	Flexible with dirty floating	Flexible with dirty floating
<b>Currency denomination for public / private debt</b>	All international debt in \$N	Bond issuance in \$N (public and private); starting portfolio investment in sovereign bonds and, mainly, in equity in \$\$	↑Portfolio investment in equity and, mainly, sovereign bonds in \$\$; ↑ private debt in \$N	Further ↑ in portfolio investment in sovereign bonds in \$\$ and in private debt \$N
<b>Balance sheet effects</b>	Original sin	Original sin predominant	Original sin ↓ Original sin redux ↑	Original sin ↓ Original sin redux ↑↑

Source: Authors' elaboration.